

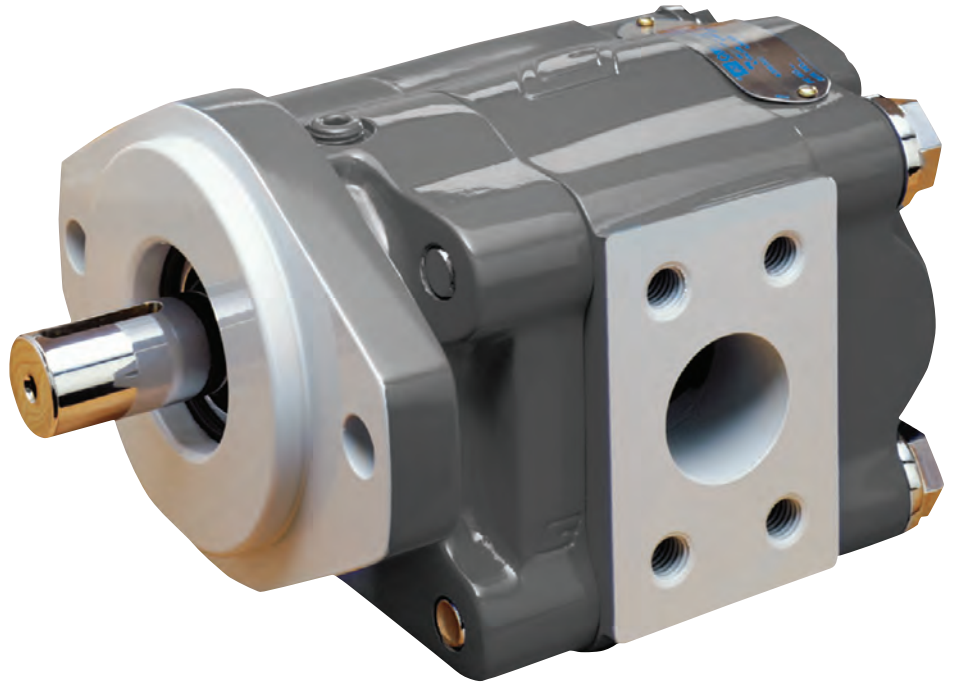

aerospace
climate control
electromechanical
filtration
fluid & gas handling
hydraulics
pneumatics
process control
sealing & shielding



PGP030/031™ Series
PGP050/051™ Series
PGP075/076™ Series
Single and Multiple Pumps and Motors



ENGINEERING YOUR SUCCESS.

The Parker Hannifin Gear Pump Division Assures:

- Consistent quality
- Technical innovation
- Premier customer service

Worldwide Sales and Service

Parker operates sales and service centers in major industrial areas worldwide. Call 1-800-C-PARKER for more information, or for a synopsis of the Gear Pump Division, contact a Parker representative.

The Gear Pump Division's ability to engineer specialty products for unique applications has kept us at the forefront of technology, and ensured our position as the industry leader. Our success has come from providing a quality product with excellent sales and service support.

We manufacture hydraulic components for a wide range of industries including:

- Construction
- Refuse/dump truck
- Material handling
- Forestry
- Agriculture
- Industrial



WARNING

FAILURE OR IMPROPER SELECTION OR IMPROPER USE OF THE PRODUCTS AND/OR SYSTEMS DESCRIBED HEREIN OR RELATED ITEMS CAN CAUSE DEATH, PERSONAL INJURY AND PROPERTY DAMAGE.

This document and other information from Parker Hannifin Corporation, its subsidiaries and authorized distributors provide product and/or system options for further investigation by users having technical expertise. It is important that you analyze all aspects of your application and review the information concerning the product or system in the current product catalog. Due to the variety of operating conditions and applications for these products or systems, the user, through its own analysis and testing, is solely responsible for making the final selection of the products and systems and assuring that all performance, safety and warning requirements of the application are met.

The products described herein, including without limitation, product features, specifications, designs, availability and pricing, are subject to change by Parker Hannifin Corporation and its subsidiaries at any time without notice.

Offer of Sale

The items described in this document are hereby offered for sale by Parker Hannifin Corporation, its subsidiaries or its authorized distributors. This offer and its acceptance are governed by the provisions stated in the "Offer of Sale".

© Copyright 2001, Parker Hannifin Corporation, All Rights Reserved.



Parker Hannifin Corporation
Gear Pump Division
Youngstown, Ohio USA

Index

Average Output Flow - Pumps 2
Average Input Power - Pumps 3
PL Factor 3
Average Performance Data - Motors 030/050/075 4
Average Performance Data - Motors 031/051/076 5
Dimensional Data 6-7
Approximate Weight 6
030/031 Series Coding 8
050/051 Series Coding 14
075/076 Series Coding 19
Offer of Sale 24

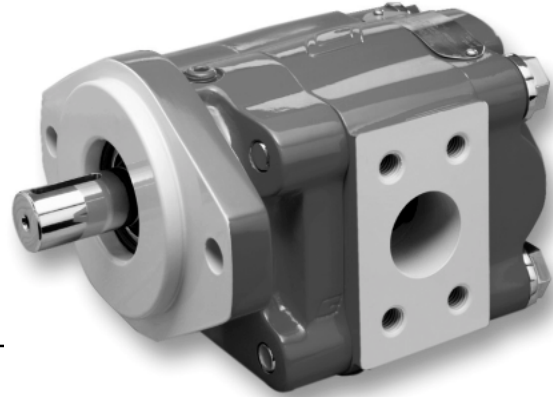

Pump/Valve Products

PGP030/031

- Flows to 41 GPM
- Pressures to 3000 psi
- Speeds to 2400 rpm
- Priority valves
- Two-speed valves
- Piggybacks
- Winch motors
- Flow dividers

PGP050/051

- Flows to 66 GPM
- Pressures to 3000 psi
- Speeds to 2400 rpm
- Priority valves
- Two-speed valves
- Unloader valve
- Winch motors
- Flow dividers
- Piggybacks

PGP075/076

- Flows to 128 GPM
- Pressures to 3000 psi
- Speeds to 2400 rpm
- Two-speed valves
- Piggybacks
- Winch motors
- Flow dividers

Performance Data

Performance data shown are the average results based on a series of laboratory tests of production units and are not necessarily representative of any one unit. Tests were run with the oil reservoir temperature at 120°F and

viscosity 150 SSU at 100°F. Requests for more specific data should be directed to our Product Support Department through our sales representatives.

PGP030/031

Flow data at 2500 PSI (172 bar) unless noted.

Speed RPM	Gear Width Output (gpm/lpm)				
	1"	1 ¼"	1 ½"	1 ¾"	2"
900	6.5	8	10	12	13.5
	24.5	30	38	45.5	51
1200	9	11.5	14	16	18.5
	34	43.5	53	60.5	70
1500	11.5	14.5	17.5	20.5	23.5
	43.5	55	66	77.5	89
1800	14	18	21.5	25	29
	53	68	81.5	94.5	110
2100	16.5	21	25	29.5	34
	62.5	79.5	94.5	112	129
2400	19	24	29	34	39
	72	91	110	129	148

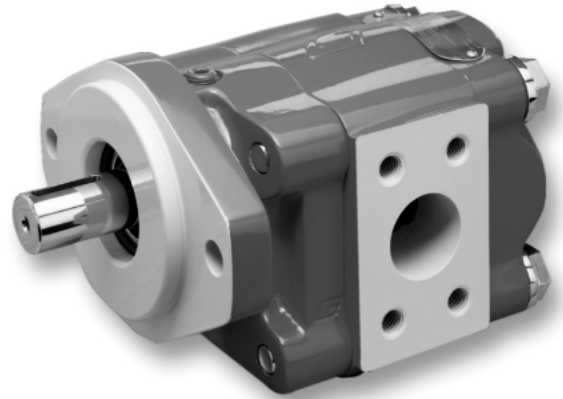

PGP050/051

Flow data at 2500 PSI (172 bar) unless noted.

Speed RPM	Gear Width Output (gpm/lpm)						
	1"	1 ¼"	1 ½"	1 ¾"	2"	2 ¼"	2 ½"
900	8.5	10.5	13	15	17.5	20	22
	32	39.5	49	57	66	75.5	83.5
1200	12	15	18	21	24	27	30
	45.5	57	68	79.5	91	102	114
1500	15	19	23	27	31	35	39
	57	72	87	102	117	132	148
1800	18	23	27.5	32.5	37.5	42	47
	68	87	104	123	142	159	178
2100	21.5	27	32.5	38.5	44	49.5	55
	81.5	102	123	146	167	187	208
2400	25	31	37	44	51	57	63.5
	94.5	117	140	167	193	216	240

PGP075/076

Flow data at 2500 PSI (172 bar) unless noted.

Speed RPM	Gear Width Output (gpm/lpm)								
	1"	1 ¼"	1 ½"	1 ¾"	2"	2 ¼"	2 ½"	2 ¾"	3"
900	11.5	15.5	19.5	23	27	30.5	34.5	38	42
	43.5	58.5	74	87	102	115.5	130.5	144	159
1200	17	22	27	32	37.5	42	48	52.5	58
	64.5	83.5	102	121	142	159	182	199	220
1500	22	29	35.5	41.5	48	54.5	61	67	74
	83.5	110	134	157	182	206	231	254	280
1800	27.5	35.5	43.5	51	59	66	74	81.5	90
	104	134	165	193	223	250	280	308	341
2100	33	42	51.5	60	69.5	78	87	96.5	106
	125	159	195	227	263	295	329	365	401
2400	38	49	59.5	70	80	90	101	111	122
	144	185	225	265	303	341	382	420	462

*Flow data at 2000 PSI (138 bar) rated pressure.

PL FACTOR

Each section of a multiple pump or motor should be regarded as a single unit with corresponding delivery and power input requirements. Since the entire input horsepower is fed through a common drive shaft, the power delivered to or from the unit is limited by the physical strength of the shaft. This limit is defined as a

“PL” factor; “P” being the operating pressure and “L” the summation of gear widths.

In multiple units the “PL” must be calculated for the first connecting shaft as well as the drive shaft. Each style or type of shaft has a unique “PL” factor as noted in the table below.

PGP030/031

Power data at 2500 PSI (172 bar) unless noted.

Speed RPM	Gear Width Inches (HP/kW)				
	1"	1 ¼"	1 ½"	1 ¾"	2"
900	14	17	20	23	25
	11	13	15	17	19
1200	19	22	26	30	33
	14	17	20	22	25
1500	23	28	33	37	42
	17	21	24	27	31
1800	27	33	39	44	50
	20	25	29	33	37
2100	32	38	45	51	58
	24	29	34	38	43
2400	36	44	51	58	66
	26	33	38	43	49

Pressure X Total Gear Width = PL
**PL MUST NOT EXCEED NUMBER
 SHOWN FOR APPROPRIATE SHAFT.**

PL Chart		
Shaft Style	Integral Shaft & Gear	Two Piece Style
030/031		
SAE "A" Spline	2,600	2,600
SAE "B" Spline	7,900	5,850
SAE "B" Key	4,850	4,850
SAE "BB" Spline	12,150	--
SAE "BB" Key	7,250	5,850
SAE "C" Spline	--	5,850
Connecting Shaft	--	5,850
050/051		
SAE "B" Spline	6,100	6,100
SAE "B-B" Spline	9,400	--
SAE "B-B" Key	5,600	5,600
SAE "C" Spline	12,900	8,500
SAE "C" Key	10,900	8,500
Connecting Shaft	--	8,500
075/076		
SAE "C" Single	8,000	8,000
SAE "C" Tandem	12,500	--
SAE "C" Key	7,500	7,500
Connecting Shaft	--	10,000

PGP050/051

Input data at 2000 PSI (138 bar) rated pressure.

Speed RPM	Gear Width Inches (HP/kW)						
	1"	1 ¼"	1 ½"	1 ¾"	2"	2 ¼"	2 ½"
900	19	22	26	30	34	38	42
	14	17	20	23	26	29	32
1200	25	30	34	40	45	51	56
	18	22	26	30	34	38	42
1500	31	37	43	50	56	63	69
	23	27	32	37	42	47	51
1800	36	44	51	59	67	75	82
	27	33	38	44	50	56	61
2100	42	51	60	69	78	87	96
	31	38	44	51	58	65	72
2400	47	57	68	79	89	99	110
	35	43	51	59	66	74	82

PGP075/076

Input data at 2000 PSI (138 bar) rated pressure.

Speed RPM	Gear Width Inches (HP/kW)								
	1"	1 ¼"	1 ½"	1 ¾"	2"	2 ¼"	2 ½"	2 ¾"*	3"*
900	26	32	39	45	51	58	64	57	62
	19	24	29	34	38	43	48	42	46
1200	35	43	52	60	69	78	86	76	83
	26	32	39	45	51	58	64	57	62
1500	44	55	65	76	87	98	109	96	105
	33	41	49	57	65	73	81	72	78
1800	53	66	79	93	106	119	132	116	127
	39	49	59	69	79	89	99	87	95
2100	62	77	93	108	124	139	154	136	148
	46	58	69	81	92	104	115	101	111
2400	71	88	106	124	141	159	176	155	169
	53	66	79	92	105	118	132	116	126

*Power data at 2500 PSI (172 bar) unless noted.



PGM030

Motor performance data at 2000 PSI (138 bar).

Speed RPM	1" Gear			1 ½" Gear			2" Gear		
	Output		Input	Output		Input	Output		Input
	Torque	Power	Flow	Torque	Power	Flow	Torque	Power	Flow
800	550	7	9	870	11	13	1150	14.5	17
	62	5	34	98.5	8	49	130	11	64.5
1200	550	10.5	13	870	16.5	18	1150	22	23.5
	62	8	49	98.5	12.5	68	130	16.5	89
1600	550	14	16	860	22	23	1140	29	30.5
	62	10.5	60.5	97	16.5	87	129	21.5	115
2000	550	17.5	19.5	850	27	28	1125	36	37
	62	13	74	96	20	106	127	27	140

U.S./Metric Torque: In.-lbs. Flow: GPM Power: HP
Nm LPM kW

PGM050

Motor performance data at 2000 PSI (138 bar).

Speed RPM	1" Gear			1 ½" Gear			2" Gear			2½" Gear		
	Output		Input	Output		Input	Output		Input	Output		Input
	Torque	Power	Flow	Torque	Power	Flow	Torque	Power	Flow	Torque	Power	Flow
800	670	8.5	10.5	1070	13.5	15.5	1450	18	21	1850	23.5	26
	75.5	6.5	39.5	121	10	58.5	164	13.5	79.5	209	17.5	98.5
1200	680	13	15.5	1075	20.5	22.5	1450	27.5	30.5	1840	35	37.5
	77	9.5	58.5	121.5	15	85	164	20.5	115	208	26	142
1600	670	17	20	1045	26.5	30	1440	36.5	40	1750	44.5	49.5
	75.5	12.5	75.5	118	20	114	162.5	27	151	197.5	33	187
2000	660	21	25	1030	32.5	37	1415	44.5	49	1720	54.5	61.5
	74.5	15.5	94.5	116.5	24	140	160	33	185	194.5	40.5	233

U.S./Metric Torque: In.-lbs. Flow: GPM Power: HP
Nm LPM kW

PGM075

Motor performance data at 2000 PSI (138 bar).

Speed RPM	1" Gear			1 ½" Gear			2" Gear			2½" Gear			3" Gear		
	Output		Input	Output		Input	Output		Input	Output		Input	Output		Input
	Torque	Power	Flow	Torque	Power	Flow	Torque	Power	Flow	Torque	Power	Flow	Torque	Power	Flow
800	1050	13.5	20.5	1650	21	28	2200	28	35.5	2875	36.5	43	3625	46	50.5
	118.5	10	77.5	186.5	15.5	106	248.5	21	134	325	27	163	409.5	34.5	191
1200	1025	19.5	27.5	1600	30.5	38	2200	42	49.5	2850	54	60.5	3575	68	72
	116	14.5	104	181	22.5	144	248.5	31.5	187	322	40.5	229	404	50.5	273
1600	1000	25.5	34	1575	40	49	2175	55	64	2800	71	78.5	3500	89	93
	113	19	129	178	30	185	245.5	41	242	316.5	53	297	395.5	66.5	352
2000	950	30	41.5	1550	49	59	2175	67.5	78	2750	87	96.5	3425	109	114
	107.5	22.5	157	175	36.5	223	245.5	50.5	295	310.5	65	365	387	81.5	431

U.S./Metric Torque: In.-lbs. Flow: GPM Power: HP
Nm LPM kW

PGM031

Motor performance data at 2500 PSI (172 bar).

Speed RPM	1" Gear			1 ½" Gear			2" Gear		
	Output		Input	Output		Input	Output		Input
	Torque	Power	Flow	Torque	Power	Flow	Torque	Power	Flow
800	675	8.5	9	1035	13	13	1385	17.5	17
	76.5	6.5	34	117	9.5	49	156.5	13	64.5
1200	685	13	13	1055	20	18	1410	27	23.5
	77.5	9.5	49	119	15	68	159.5	20	89
1600	680	17.5	16	1030	26	23	1390	35	30.5
	77	13	60.5	116.5	19.5	87	157	26	115
2000	660	21	19.5	1010	32	28	1370	43.5	37
	74.5	15.5	74	114	24	106	155	32.5	140

U.S./Metric Torque: In.-lbs. Flow: GPM Power: HP
Nm LPM kW

PGM051

Motor performance data at 2500 PSI (172 bar).

Speed RPM	1" Gear			1 ½" Gear			2" Gear			2½" Gear		
	Output		Input	Output		Input	Output		Input	Output		Input
	Torque	Power	Flow	Torque	Power	Flow	Torque	Power	Flow	Torque	Power	Flow
800	825	10.5	10.5	1310	16.5	15.5	1810	23	21	2330	29.5	26
	93	8	39.5	148	12.5	58.5	204.5	17	79.5	263.5	22	98.5
1200	850	16	15.5	1340	25.5	22.5	1830	35	30.5	2340	44.5	37.5
	96	12	58.5	151.5	19	85	207	26	115	264.5	33	142
1600	830	21	20	1330	34	30	1805	46	40	2300	58.5	49.5
	94	15.5	75.5	150.5	25.5	114	204	34.5	151	260	43.5	187
2000	800	25.5	25	1290	41	37	1770	56	49	2250	71.5	61.5
	90.5	19	94.5	146	30.5	140	200	42	185	254	53.5	233

U.S./Metric Torque: In.-lbs. Flow: GPM Power: HP
Nm LPM kW

PGM076

Motor performance data at 2500 PSI (172 bar).

Speed RPM	1" Gear			1 ½" Gear			2" Gear			2½" Gear			3" Gear*		
	Output		Input	Output		Input	Output		Input	Output		Input	Output		Input
	Torque	Power	Flow	Torque	Power	Flow	Torque	Power	Flow	Torque	Power	Flow	Torque	Power	Flow
800	1410	18	20.5	2140	27	28	2875	36.5	35.5	3650	46.5	43	3625	46	50.5
	159.5	13.5	77.5	242	20	106	325	27	134	412.5	34.6	163	409.5	34.5	191
1200	1400	26.5	27.5	2140	41	38	2870	54.5	49.5	3650	69.5	60.5	3575	68	72
	158	20	104	242	30.5	144	324.5	40.5	187	412.5	52	229	404	50.5	273
1600	1375	35	34	2110	53.5	49	2830	72	64	3600	91.5	78.5	3500	89	93
	155.5	26	129	238.5	40	185	319.5	53.5	242	406.5	68	297	395.5	66.5	352
2000	1350	43	41.5	2090	66.5	59	2800	89	78	3500	111	96.5	3425	109	114
	152.5	32	157	236	49.5	223	316.5	66.5	295	395.5	83	365	387	81.5	431

U.S./Metric Torque: In.-lbs. Flow: GPM Power: HP
Nm LPM kW

*Motor performance data at 2000 PSI (138 bar).

Pumps and Motors (see drawings on page 7)

Model		A ⁽¹⁾	Bs ⁽²⁾⁽³⁾	Bm ⁽³⁾⁽⁴⁾	C ⁽⁵⁾⁽⁶⁾	D ⁽⁵⁾⁽⁷⁾	E ⁽³⁾	F ⁽²⁾	G	H	I	J	K	L ⁽³⁾⁽⁸⁾	M ⁽⁴⁾
030/031	in.	1.62	5.44	8.69	5.44	5.88	2.94	0.75	1.75	2.50	0.88	2.69	5.38	3.31	3.25
	mm.	41.3	138.1	220.7	138.1	149.2	74.6	19.1	44.5	63.5	22.2	68.3	136.5	84.1	82.6
050/051	in.	2.19	5.88	9.50	5.44	5.88	3.38	0.75	1.75	2.88	1.00	3.00	6.00	3.75	3.62
	mm.	55.6	149.2	241.3	138.1	149.2	85.7	19.1	44.5	73.0	25.4	76.2	152.4	95.3	92.1
075/076	in.	2.19	6.75	10.75	7.75	7.94	3.75	1.00	2.00	3.00	1.25	3.94	7.88	4.75	4.00
	mm.	55.6	171.5	273.1	196.9	201.6	95.3	25.4	50.8	76.2	31.8	100.0	200.0	120.7	101.6

U.S./Metric

NOTES

1. Dimension will vary with shaft type
2. Dimension + gear width
3. Dimension is for Type 1 SEC. For Type 2: subtract 1.12" (28.4 mm) for 030/031; subtract 1.00" (25.4 mm) for 050/051.
4. Dimension + total gear width
5. Dimension will vary with port type. Subtract 0.25" (6.4 mm) for S.F. ports.
6. For 2.25" and 2.50" gear width in 050/051 series, dimension is 6.75" (171.5 mm).
7. Dimension is for wide B-C. Narrow B-C dimensions: 5.00" (127 mm) for 030/031 and 050/051; 7.19" (182.6 mm) for 075/076.
8. Dimension + ½ front section gear width

Approximate Weight: Pumps and Motors

Single Unit

Model	Unit Weight	1"	1 ¼"	1 ½"	1 ¾"	2"	2 ¼"	2 ½"	2 ¾"	3"
030/031	Pounds	33	34	35	36	37	-	-	-	-
	KG	15	15.5	16	16.5	17	-	-	-	-
050/051	Pounds	37	38.5	40	41.5	43	48.5	50	-	-
	KG	17	17.5	18	19	19.5	22	22.5	-	-
075/076	Pounds	72	75	77	80	82	85	87	90	92
	KG	33	34	35	36	37	39	40	41	42

Approximate Weight: Pumps and Motors

Multiple Unit*

Model	Add per gear section	1"	1 ¼"	1 ½"	1 ¾"	2"	2 ¼"	2 ½"	2 ¾"	3"
030/031	Pounds	27	28	29	31	32	-	-	-	-
	KG	12	12.5	13	14	14.5	-	-	-	-
050/051	Pounds	31	32.5	34	35.5	37	42.5	44	-	-
	KG	14	15	15.5	16	17	19	20	-	-
075/076	Pounds	59	62	64	67	69	72	74	77	79
	KG	27	28	29	31	32	33	34	35	36

*Determine the approximate weight from Single Unit chart and add weight of each additional assembly from this chart.

Single Unit - 030/031/050/051

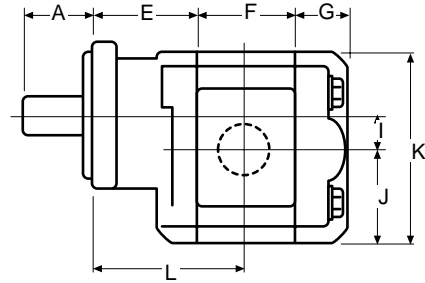
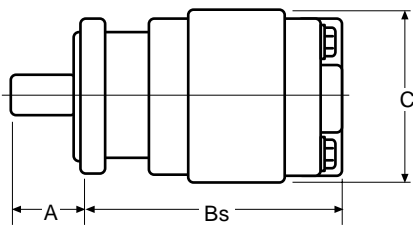

Single Unit - 075/076

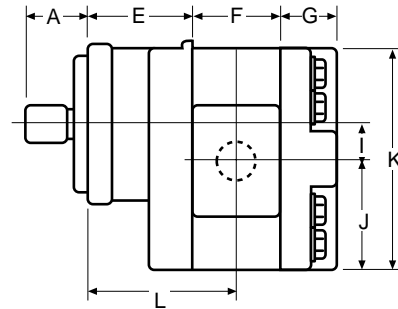
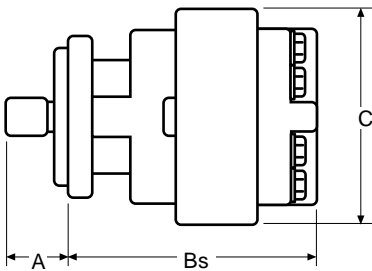

Multiple Unit - 030/031/050/051

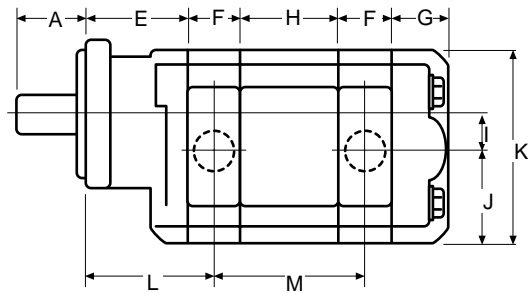
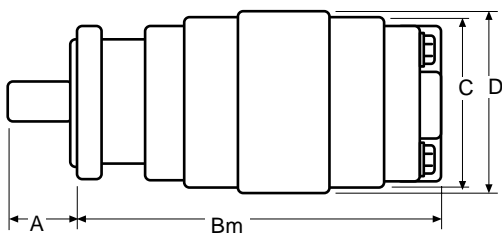

Multiple Unit - 075/076

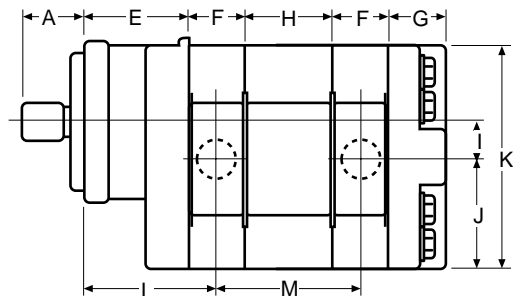
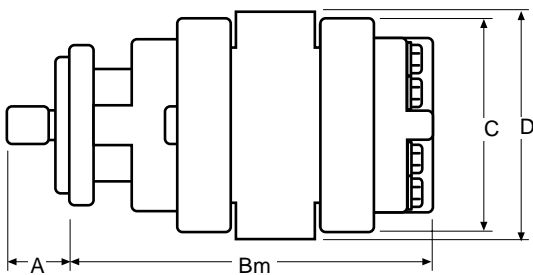

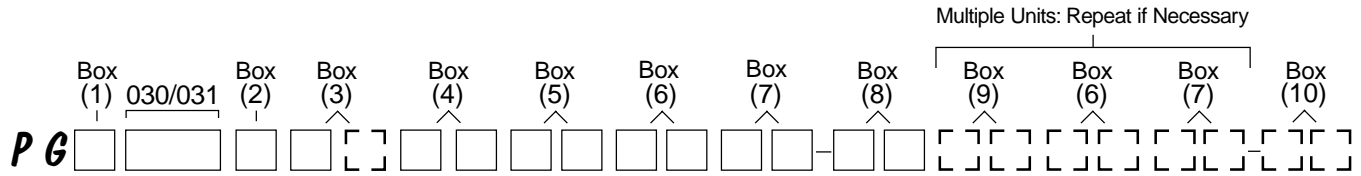

Box 1 Pump/Motor

P	Pump
M	Motor

Box 2 Unit

A	Single Unit
B	Tandem Unit
C	Single or Tandem w. two-piece shaft (O.B. bearing required)

Box 3 Shaft End Cover

1	Pump, cw w/o O.B. bearing
2	Pump, ccw w/o O.B. bearing
3	Pump, bi-rotational w/o O.B. bearing (030 series only)
4	Pump, cw with O.B. bearing
5	Pump, ccw with O.B. bearing
6	Pump, bi-rotational with O.B. bearing (030 series only)
8	Motor, bi-rot. with O.B. bearing + 1/4" NPT drain
9	Motor, bi-rot. w/o O.B. bearing + 1/4" NPT drain
18	Motor, bi-rot. with O.B. bearing + 1/4" BSPP drain
19	Motor, bi-rot. w/o O.B. bearing + 1/4" BSPP drain

Box 4 Shaft End Cover (type 1 unless noted)

00	Pad mount
05	6 bolt flange - 3.25" dia. bolt circle: Pilot Dia. 2 5/8"
42	SAE 4 bolt "B" ANSI 101-4: Pilot Dia. 4"
78	SAE 4 bolt "C" ANSI 127-4: Pilot Dia. 5"
91	030-030, 031-031, & 050-030, 051-031 for piggyback: Pilot Dia. 4"
92	075-030, 076-031 for piggyback: Pilot Dia. 5"
94	SAE 2 bolt "A" ANSI 82-2: Pilot Dia. 3 1/4"
96	SAE 2 bolt "B" ANSI 101-2, type 2 : Pilot Dia. 4"
(not available with O.B. bearing)	
97	SAE 2 bolt "B" ANSI 101-2: Pilot Dia. 4"

Box 5 Port End Cover (Rear Ported)

Left	Right	Single	Tandem	Extended Studs
Unported				
-	-	BE	BI	BY
NPT Porting (030 series only)				
3/4"	-	KE	KI	KY
-	3/4"	LE	LI	LY
3/4"	3/4"	ME	MI	MY
NPT Porting (030 series only) - Modified Casting*				
1"	1"	QU	QU	-

For All Units
 To determine direction of shaft rotation, view the unit with the shaft pointing toward you, and the idler (driven) gear beneath the shaft. With clockwise rotation, flow will be left to right. The pump inlet port will be on the left, outlet on the right. The flow is in the opposite direction with counter-clockwise rotation. Inverting the pump will reverse the inlet and outlet ports but not the direction of rotation.

Box 5 Port End Cover (Rear Ported) continued

Left	Right	Single	Tandem	Extended Studs
O.D.T. Porting				
3/4"	-	CE	CI	CY
-	3/4"	DE	DI	DY
3/4"	3/4"	FE	FI	FY
1"	3/4"	GE	GI	GY
3/4"	1"	HE	HI	HY

O.D. Tube Porting (30 series only)

1"	1"	JE	JI	JY
----	----	-----------	-----------	-----------

O.D. Tube Porting - Modified Casting*

3/4"	-	CA	CU	CO
-	3/4"	DA	DU	DO
3/4"	3/4"	JA	JU	BO
1"	3/4"	KA	KU	-
3/4"	1"	LA	LU	-
1"	-	MA	MU	YO
-	1"	RA	SU	RO
1"	1"	ZA	ZU	ZO
1 1/4"	1"	GU	GU	-
1"	1 1/4"	HU	HU	-

BSPP Porting

3/4"	-	WE	WI	WY
-	3/4"	XE	XI	XY
3/4"	3/4"	ZE	ZI	ZY

Metric Straight Thread

3/4"	-	NE	NI	NY
-	3/4"	PE	PI	PY
3/4"	3/4"	QE	QI	QY
1"	3/4"	RE	RI	RY
3/4"	1"	SE	SI	SY

Port End Cover (5) (Side Ported)

Left	Right	Single	Tandem	Extended Studs
O.D. Tube Porting - Modified Casting*				
1 1/4"	1"	TU	TU	-
1"	1 1/4"	XU	XU	-
CW CCW Double				
Piggyback Port End - Pump Only				
Type 030-030, 031-031				
(double 030-030 only)				
KO LO MO				

* Modified PEC casting is for higher pressure/larger port applications.

Box 6 Gear Housing												
		030 Series						031 Series				
Housing Code	07	10	12	15	17	20	10	12	15	17	20	
Displacement (C.I.R.)	1.48	1.97	2.46	2.96	3.45	3.94	1.97	2.46	2.96	3.45	3.94	
Maximum (PSI)	2500	2500	2500	2500	2250	2250	3000	3000	3000	2500	2500	
IN	OUT	CW	CCW									
-	-	AB	AB	X	X	X	X	X	X	X	X	
No Porting												
NPT Porting												
1/2"	-	IL	IM	X	X							
-	1/2"	IM	IL	X	X							
1/2"	1/2"	IR	IR	X								
3/4"	-	IC	ID		X	X	X	X	X			
-	3/4"	ID	IC		X	X	X		X			
3/4"	3/4"	IF	IF		X	X	X	X	X			
1"	3/4"	IJ	IG		X*	X	X	X				
1 1/4"	3/4"	IK	IH				X*	X				
1"	-	YC	YD		X*	X	X	X				
-	1"	YD	YC			X	X	X				
1"	1"	YF	YF			X	X	X	X			
1 1/4"	1"	YJ	YG				X*	X	X			
1 1/4"	-	IA	IB				X*	X	X			
-	1 1/4"	IB	IA					X	X			
1 1/4"	1 1/4"	YL	YL					X	X			
1 1/2"	-	YA	YB								X*	
1 1/2"	1 1/4"	YP	YM									X*
OD Tube Porting												
3/4"	-	EC	ED		2000	X	X	X		X*	X	X
-	3/4"	ED	EC		2000	X	X	X			X	X
3/4"	3/4"	EF	EF		2000	X	X	X	X		X	X
1"	3/4"	EJ	EG		2000*	X*	X	X	X		X*	X*
1 1/4"	3/4"	EK	EH				X*	X*			X*	X*
1 1/2"	3/4"	IP	IN					X*	X*			X*
7/8"	-	EZ	-			X						
-	7/8"	-	EZ			X						
1"	7/8"	EM	EL			X*						
1"	-	AC	AD		X*	2000	X	X	X		X*	X*
-	1"	AD	AC			2000	X	X	X		2500	X
1"	1"	AF	AF				X	X	X		2500	X
1 1/4"	1"	AJ	AG				X*	X*	X		2500*	X*
1 1/2"	1"	AK	AH					X*	X*			X*
1 1/4"	-	AA	AO				X*	2000			X*	X*
-	1 1/4"	AO	AA					2000				
1 1/4"	1 1/4"	AL	AL					2000	X			X
1 1/2"	1 1/4"	AP	AM					2000*	X*			X*
1 1/2"	-	AE	AU					X*	2000			X*
-	1 1/2"	AU	AE						2000			

*This porting is acceptable for low pressure inlet port only.

NOTES

1. Shaded cells are acceptable for motor codes.
2. NPT ports are not recommended for use at pressures in excess of 1500 PSI.
3. "X" Means both codes are available.
4. "2000" or "2500" indicates maximum pressure rating on port.

Box 6 Gear Housing *continued*

		030 Series						031 Series				
Housing Code		07	10	12	15	17	20	10	12	15	17	20
Displacement (C.I.R.)		1.48	1.97	2.46	2.96	3.45	3.94	1.97	2.46	2.96	3.45	3.94
Maximum (PSI)		2500	2500	2500	2500	2250	2250	3000	3000	3000	2500	2500
IN	OUT CW CCW											
Split Flange Porting												
3/4"	- UC UD	X	X	UD	X			X	X	X	X	
-	3/4" UD UC	X	X	UD	X			X	X	X	X	
3/4"	3/4" UF UF	X	X	X				X	X	X		
1"	3/4" UJ UG	X	X	UJ	UJ	X		X*	X			
1 1/4"	3/4" UK UH		X	X	X	X		X*	X*			
1"	- OC OD		X	X	X	OD		2500	X	X		
-	1" OD OC		X	X	X	OD		2500	X	X		
1"	1" OF OF	X	X	X	X	X		2500	X	X	X	X
1 1/4"	1" OJ OG		X*	X	X	X			X*	X*	X	X
1 1/2"	1" OK OH				X*	X					X*	X*
1 1/4"	- OA OB		2000	X	X	X		X*	2500			
-	1 1/4" OB OA		2000	X	X	X			2500			
1 1/4"	1 1/4" OL OL			X	X	X					X	X
1 1/2"	1 1/4" OP OM				X*	X					X*	X*
1 1/2"	- OE OU				2000	X					X*	X
-	1 1/2" OU OE				2000	X						X
BSPP Porting												
3/4"	- YN YQ X*	X	X	X	X	X		2500	X	X		YQ
-	3/4" YQ YN	X	X	X	X	X		2500	X	X		YQ
3/4"	3/4" YS YS	X	X	X	X	X		2500	X	X		X
1"	3/4" YV YT	X*	X*	YV	YV			2500*	X*	YV*	X	YV
1 1/4"	3/4" YW YU				X*	X*				YU*	X*	
1"	- SL RQ		2000	X	X	X		SL*	2500	X		
-	1" RQ SL		2000	X	X	X			2500	X		
1"	1" MP MP		2000	X	X						X	X
1 1/4"	1" IX VY			X*	X*	X*			2500*	X*		
1 1/4"	- NJ UI				2000	X						X*
-	1 1/4" UI NJ				2000	X						
1 1/4"	1 1/4" PF PF					2000						
1 1/2"	1" VI HW										X*	X*
Metric Straight Thread Porting												
3/4"	- EN TQ	X	X	TQ				2500	X			
-	3/4" TQ EN	X	X	TQ				2500	X			
3/4"	3/4" ES ES	X	X					2500	X			
1"	3/4" EV ET	X*	X*	EV	EV				X*	X*		
1 1/4"	3/4" EW EU									X*		
1"	- NL ER	X*		X	ER	ER			2500			
-	1" ER NL			X	ER	ER			2500			
1"	1" CM CM		2000	X					2500			
1 1/4"	1" EX VE			X*	X*	X*			2500*			
1 1/2"	1" VA HA			X*	X*	X*					X*	X*
1 1/4"	1 1/4" PA PA				2000	X						
1 1/2"	1 1/4" SA QA					X*						

* This porting is acceptable for low pressure inlet port only.

NOTES

1. Shaded cells are acceptable for motor codes.
2. "X" Means both codes are available.
3. "2000" or "2500" indicates maximum pressure rating on port.



Box 6 Gear Housing <i>continued</i>											
030 Series						031 Series					
Housing Code	07	10	12	15	17	20	10	12	15	17	20
Displacement (C.I.R.)	1.48	1.97	2.46	2.96	3.45	3.94	1.97	2.46	2.96	3.45	3.94
Maximum (PSI)	2500	2500	2500	2500	2250	2250	3000	3000	3000	2500	2500
IN	OUT	CW		CCW							
							Metric Straight Thread Porting				
3/4"	-	VN	VQ	X	X	X	X	X	X		X
-	3/4"	VQ	VN	X	X	X	X	X			X
3/4"	3/4"	VS	VS	X	X						X
1"	3/4"	RV	VT	X	X	X	X			X*	X
1 1/4"	3/4"	RW	RU		X*	X			X*	X*	
1"	-	UL	UR	X	X	X	X	X	2500	X	X
-	1"	UR	UL	X	X	X	X	X	2500	X	X
1"	1"	UM	UM		X	X	X		X	X	X
1 1/4"	1"	UX	VU		X*	X	X	X	X*	X*	X
1 1/2"	1"	VO	HO				X*	X		X*	X*
1 1/4"	-	NO	UO			X		X	X*	2500	
-	1 1/4"	UO	NO			X		X	X*	2500	
1 1/4"	1 1/4"	PO	PO		X	X	X				X
1 1/2"	1 1/4"	SO	QO			X*	X			X*	X*
1 1/2"	-	UY	TO		X*	2000				X*	X
-	1 1/2"	TO	UY			2000					X

* This porting is acceptable for low pressure inlet port only.

NOTES

1. Shaded cells are acceptable for motor codes.
2. "X" Means both codes are available.
3. "2000" or "2500" indicates maximum pressure rating on port.

Box 7 Gear Width				
030 Series				
Gear Width	in. ³ /rev.	cm ³ /rev.	Max Pressure	
05	1/2"	0.99	16.1	2500 psi (172 bar)
07	3/4"	1.48	24.2	2500 psi (172 bar)
10	1"	1.97	32.3	2500 psi (172 bar)
12	1 1/4"	2.46	40.4	2500 psi (172 bar)
15	1 1/2"	2.96	48.4	2500 psi (172 bar)
17	1 3/4"	3.45	56.5	2250 psi (155 bar)
20	2"	3.94	64.6	2250 psi (155 bar)
031 Series				
Gear Width	in. ³ /rev.	cm ³ /rev.	Max Pressure	
05	1/2"	0.99	16.1	3000 psi (207 bar)
07	3/4"	1.48	24.2	3000 psi (207 bar)
10	1"	1.97	32.3	3000 psi (207 bar)
12	1 1/4"	2.46	40.4	3000 psi (207 bar)
15	1 1/2"	2.96	48.4	3000 psi (207 bar)
17	1 3/4"	3.45	56.5	2500 psi (172 bar)
20	2"	3.94	64.6	2500 psi (172 bar)

Box 8 Shaft Type (type 1 unless noted)

For single, tandem, or two-piece shaft unless noted.

07	SAE "C" 14 tooth spline 1.25" dia., ANSI 32-4 (two piece only)
12	Keyed shaft .75 dia., .19"X.19"X1.56" key (two piece only)
14	030-030, 031-031 piggyback shaft
22	050-030, 051-031 piggyback shaft
23	075-030, 076-031 piggyback shaft
25	SAE "B" 13 tooth spline .88" dia., ANSI 22-4
30	SAE "B" keyed .88" dia., ¼"X3/8" X 1" key, ANSI 22-1
32	Clutch pump shaft, tapered & keyed, 1:4 taper (single & two piece), #6 woodruff key
43	SAE "B-B" keyed 1.00" dia. ¼"X3/8"X1 ¼" key, ANSI 25-1 modified length
65	SAE "B" 13 tooth spline .875" dia., ANSI 22-4, type 2 (single & tandem)
66	SAE "B" keyed .88" dia, ¼"X3/8"X1" key, type 2 (single & tandem)
67	SAE "B-B" keyed 1.00" dia., ¼"X3/8"X1 ¼" key, ANSI 25-1 modified length, type 2 (single & tandem)
68	6 tooth spline 1.00" dia.
90	SAE "B" keyed w/ 5/8"-18 thread, .875" dia, ANSI 22-2 modified length (single & tandem)
95	SAE "A" 9 tooth spline, .62" dia. ANSI 16-4 (single only)
98	SAE "B-B" 15 tooth spline, 1.00" dia., ANSI 25-4 (single & tandem)

Box 9 Bearing Carriers Pump Only

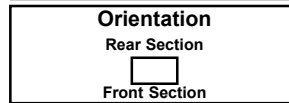

Common Inlet Passage

IN	OUT	CW	CCW
-	-		
		C	D
*	-	A	U

* 031 Series only. Used when only one adjacent gear housing has an inlet port.

NPT Porting
 (030 Series only)

1"	-	TB	BT
1 ¼"	-	VB	BV
1"	¾"	TX	XT
1 ¼"	¾"	VX	XV
1 ¼"	1"	VZ	ZV
1"	¾"	TJ	JT
1 ¼"	¾"	VJ	JV
1 ¼"	1"	VK	KV
1 ½"	1"	KW	-
1"	¾"	ZX	XZ
1"	¾"	ZS	SZ

ODT Porting

1"	-	CB	BC
1 ¼"	-	DB	BD
1 ½"	-	FB	BF
*	-	¾"	-
1"	¾"	CJ	JC
1 ¼"	¾"	DJ	JD
1 ½"	¾"	FJ	JF
1 ¼"	1"	DK	KD
1 ½"	1"	FK	KF
* 030 Series only.			
1"	¾"	CR	RC
1 ¼"	¾"	DR	RD
* 1 ½"	¾"	FR	RF
1 ¼"	1"	DS	SD
1 ½"	1"	FS	SF
* 030 Series only.			
1"	¾"	KJ	JK
1"	¾"	KX	XK

Split Flange Porting

IN	OUT	CW	CCW
1"	-	LB	BL
1 ¼"	-	MB	BM
1 ½"	-	NB	BN
-	¾"	BR	RB
1"	¾"	LR	RL
1 ¼"	¾"	MR	RM
1 ½"	¾"	NR	RN
1 ¼"	1"	MS	SM
1 ½"	1"	NS	SN
1"	¾"	LX	XL
1 ¼"	¾"	MX	XM
* 1 ½"	¾"	NX	XN
1 ¼"	1"	MZ	ZM
1 ½"	1"	NZ	ZN
* 030 Series only.			
1"	¾"	SR	RS
1"	¾"	RZ	ZR

BSPB Porting

1"	-	CX	XC
1 ¼"	-	DX	XD
1 ½"	-	FX	XF
*	-	¾"	-
1"	¾"	CT	TC
1 ¼"	¾"	DT	TD
1 ½"	¾"	FT	TF
1 ¼"	1"	DV	VD
1 ½"	1"	FV	VF
* 031 Series only.			
1"	¾"	GM	MG
1 ¼"	¾"	HM	MH
1 ¼"	1"	HN	NH
1 ½"	1"	WN	NW
1"	¾"	PN	NP
1"	¾"	SX	XS

Box 9 Bearing Carriers (Pump Only) - continued

Metric Split Flange Porting			
IN	OUT	CW	CCW
1"	-	CH	HC
1 1/4"	-	DH	HD
1 1/2"	-	FH	HF
-	3/4"	PW	WP
1"	3/4"	CW	WC
1 1/4"	3/4"	DW	WD
1 1/2"	3/4"	FW	WF
1 1/4"	1"	DC	CD
1 1/2"	1"	FC	CF
1"	3/4"	GQ	QG
1 1/4"	3/4"	HQ	QH
1 1/4"	1"	HS	SH
1 1/2"	1"	WS	SW
1"	3/4"	ST	TS
1"	3/4"	PX	XP

Metric Straight Thread Porting			
IN	OUT	CW	CCW
1"	-	CL	LC
1 1/4"	-	DL	LD
1 1/2"	-	FL	LF
1"	3/4"	CZ	ZC
1 1/4"	3/4"	DZ	ZD
1 1/2"	3/4"	FZ	ZF
1 1/4"	1"	DN	ND
1 1/2"	1"	FN	NF
1"	3/4"	GT	TG
1 1/4"	3/4"	HT	TH
1 1/4"	1"	HV	VH
1 1/2"	1"	WV	VW
1"	3/4"	KL	LK
1"	3/4"	PV	VP

Box 9 Bearing Carriers (Motor Only)

No Ports		
IN	OUT	DUAL
-	-	B

NPT Porting (030 Series only)		
1"	1"	TT
1 1/4"	1 1/4"	VV

ODT Porting		
1"	1"	CC
1 1/4"	1 1/4"	BB
1 1/2"	1 1/2"	FF

Split Flange Porting		
1"	1"	LL
1 1/4"	1 1/4"	MM
1 1/2"	1 1/2"	NN

BSPP Porting		
1"	1"	EE
1 1/4"	1 1/4"	GG

Metric Split Flange Porting		
IN	OUT	DUAL
1"	1"	RR
1 1/4"	1 1/4"	SS

Metric Straight Thread Porting		
1"	1"	KK
1 1/4"	1 1/4"	JJ

Box 10 Connecting Shaft

For connecting tandem units.

1 Connecting Shaft - Multiple Units

14 Piggyback Pump Connecting Shaft 030 to 030, 031 to 031

22 Piggyback Pump Connecting Shaft 050 to 030, 051 to 031

23 Piggyback Pump Connecting Shaft 075 to 030, 076 to 031

NOTE

Split flange thread depths may be more shallow than S.A.E. standard. Contact Product Support Department for actual dimensions.

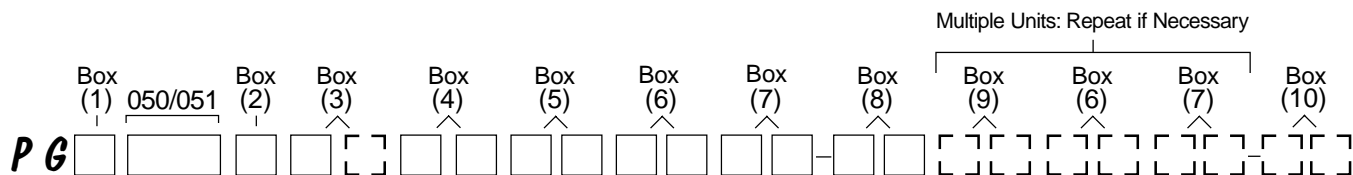

Box 1 Pump/Motor

P	Pump
M	Motor

Box 2 Unit

A	Single Unit
B	Tandem Unit
C	Single or Tandem w. two-piece shaft (O.B. bearing required)

Box 3 Shaft End Cover

1	Pump, cw w/o O.B. bearing
2	Pump, ccw w/o O.B. bearing
3	Pump, bi-rotational w/o O.B. bearing (050 series only)
4	Pump, cw with O.B. bearing
5	Pump, ccw with O.B. bearing
6	Pump, bi-rotational with O.B. bearing (050 series only)
8	Motor, bi-rot. with O.B. bearing + ¼" NPT drain
9	Motor, bi-rot. w/o O.B. bearing + ¼" NPT drain
18	Motor, bi-rot. with O.B. bearing + ¼" BSPP drain
19	Motor, bi-rot. w/o O.B. bearing + ¼" BSPP drain

Box 4 Shaft End Cover (type 1 unless noted)

00	4 bolt pad mount
42	SAE 4 bolt "B" ANSI 101-4: Pilot dia. 4"
78	SAE 4 bolt "C" ANSI 127-4: Pilot dia. 5"
91	050-050, 051-051 for piggyback: Pilot dia. 4"
92	075-050, 076-051 for piggyback: Pilot dia. 5"
96	SAE 2 bolt "B" ANSI 101-2, type 2 : Pilot dia. 4"
97	SAE 2 bolt "B" ANSI 101-2: Pilot dia. 4"
98	SAE 2 bolt "C" ANSI 127-2: Pilot dia. 5"
99	SAE 2 bolt "C" ANSI 127-2, type 2 : Pilot dia. 5"

Box 5 Port End Cover (Rear Ported)

Left	Right	Single	Tandem	Extended Studs
Unported				
-	-	BE	BI	BY

NPT Porting (050 series only)

Left	Right	Single	Tandem	Extended Studs
¾"	-	KE	KI	KY
-	¾"	LE	LI	LY
¾"	¾"	ME	MI	MY

O.D.T. Porting

Left	Right	Single	Tandem	Extended Studs
¾"	-	CE	CI	CY
-	¾"	DE	DI	DY
¾"	¾"	FE	FI	FY

Box 5 Port End Cover continued

Left	Right	Single	Tandem	Extended Studs
BSPP Porting				
¾"	-	WE	WI	WY
-	¾"	XE	XI	XY
¾"	¾"	ZE	ZI	ZY

Metric Straight Thread

Left	Right	Single	Tandem	Extended Studs
¾"	-	NE	NI	NY
-	¾"	PE	PI	PY
¾"	¾"	QE	QI	QY

Note
 ¾" PEC ports are rated to 2500 PSI max.

	CW	CCW	Double
Piggyback Port End - Pump Only			
Type 050-050, 051-051 & 050-030, 051-031	KO	LO	MO

- Optional:
- Port end cover with integral R/V
 - Larger rear ports
1 ¼ x 1 S.F. or ODT
 - Larger side ports
1 ¼ S.F. or ODT inlet
1" ODT outlet
 - Larger rear ports, but requires special gear housing and cap screws
1 ½ x 1 ½ NPT up to 1500 PSI

Contact Product Support Development for additional information.

FOR ALL UNITS
 To determine direction of shaft rotation, view the unit with the shaft pointing toward you, and the idler (driven) gear beneath the shaft. With clockwise rotation, flow will be left to right. The inlet pump port will be on the left, outlet on the right. The flow is in the opposite direction with counter-clockwise rotation. Inverting the pump will reverse the inlet and outlet ports but not the direction of rotation.

Box 6 Gear Housing																
050 Series										051 Series						
Housing Code	07	10	12	15	17	20	22	25		10	12	15	17	20	22	25
Displacement (C.I.R.)	1.91	2.55	3.19	3.83	4.46	5.10	5.74	6.38		2.55	3.19	3.83	4.46	5.10	5.74	6.38
Maximum (PSI)	2500	2500	2500	2500	2000	2000	2000	2000		3000	3000	3000	3000	2500	2500	2500
IN	OUT	CW	CCW													
-	-	AB	AB	X	X	X	X	X	X	X	X	X	X	No Porting		
														X	X	X
NPT Porting																
3/4"	-	IC	ID	X	ID	ID	ID									
-	3/4"	ID	IC	X	ID	ID	ID									
3/4"	3/4"	IF	IF	X	X	X	X	X								
1"	3/4"	IJ	IG	X*	X	X	IJ	IJ								
1 1/4"	3/4"	IK	IH			X										
1"	-	YC	YD		X	YD	YD	YD	YD							
-	1"	YD	YC		X	YD	YD	YD	YD							
1"	1"	YF	YF		X	X	X	X	X	X						
1 1/4"	1"	YJ	YG			X*	X	X	X	YJ						
1 1/4"	-	IA	IB			X*	X*	X	IB	IB						
-	1 1/4"	IB	IA					X	IB	IB						
1 1/4"	1 1/4"	YL	YL				X	X	X	X						
1 1/2"	1"	YK	YH							X						
1 1/2"	1 1/4"	YP	YM					X*	X	X						
1 1/2"	1 1/2"	YR	YR							X						
OD Tube Porting																
3/4"	-	EC	ED	2000	2000	X	ED	X		X*	X*		X			
-	3/4"	ED	EC	2000	2000	X	ED	X					X			
3/4"	3/4"	EF	EF	2000	2000	X	X	X				2500	X			
1"	3/4"	EJ	EG	2000*	2000*	X	EJ*	EJ					X			
1 1/4"	3/4"	EK	EH			X*	X*					2500*	X*			
1"	-	AC	AD	X*	X*	2000	X	AD	AD	AD	X*	X*	X*	X*	X	
-	1"	AD	AC			2000	X	AD	AD	AD				X		
1"	1"	AF	AF			2000	X	X		X				X	X	X
1 1/4"	1"	AJ	AG			2000*	X*	X*	AJ	AJ				X*		
1 1/2"	1"	AK	AH				X*	X*	X*					X*		X
1 1/4"	-	AA	AO			X*	X*	X*	AO	AO		X*	X*		X	X
-	1 1/4"	AO	AA						AO	AO					X	X
1 1/4"	1 1/4"	AL	AL					X	X	X				X	X	
1 1/2"	1 1/4"	AP	AM				X*	X*	X					X*	X*	
1 1/2"	-	AE	AU				X*	X*						X*	X*	X
-	1 1/2"	AU	AE													X
1 1/2"	1 1/2"	AR	AR							X						X

* This porting is acceptable for low pressure inlet port only.

NOTES

1. NPT ports are not recommended for use at pressures in excess of 1500 PSI.
2. Shaded cells are acceptable for motor codes.
3. "X" Means both codes are available.
4. "2000" or "2500" indicates maximum pressure rating on port.

Box 6 Gear Housing <i>continued</i>																
		050 Series							051 Series							
Housing Code		10	12	15	17	20	22	25	10	12	15	17	20	22	25	
Displacement (C.I.R.)		2.55	3.19	3.83	4.46	5.10	5.74	6.38	2.55	3.19	3.83	4.46	5.10	5.74	6.38	
Maximum (PSI)		2500	2500	2500	2000	2000	2000	2000	3000	3000	3000	3000	2500	2500	2500	
IN	OUT	CW	CCW													
Split Flange Porting																
3/4"	-	UC	UD	X	X	UD	UD		2500	X						
-	3/4"	UD	UC	X	X	UD	UD		2500	X						
3/4"	3/4"	UF	UF					X	2500	X	X					
1"	3/4"	UJ	UG	X*	X*	UJ	UJ	UJ	2500*	X*	X*					
1 1/4"	3/4"	UK	UH							X*	X*	X*				
1"	-	OC	OD	2000	X*	X	X	X	OD	X	X*	2500	X	X		
-	1"	OD	OC	2000	2000	X	X	X	OD	X		2500	X	X		
1"	1"	OF	OF		2000	X	X	X	X	X		2500	X	X	X	
1 1/4"	1"	OJ	OG		2000*	X*	X*	X	OJ	OJ		2500*	X*	X*		
1 1/2"	1"	OK	OH			X*	X*	X*	X	X		2500*	X*	X*	X	
	1 1/4"	-	OA	OB		X*	X*	X*	X		OB	OB	X*	X*		
-	1 1/4"	OA	OB				X	OB	OB							
1 1/4"	1 1/4"	OL	OL		2000	X	X	X	X				X	X	X	
1 1/2"	1 1/4"	OP	OM		2000*	X*	X*	X	X				X*	X	X	
1 1/2"	-	OE	OU			X*	X*	X	X			X*	X*	X*		
-	1 1/2"	OU	OE				X	X								
1 1/2"	1 1/2"	OR	OR				X	X	X					X	X	
2"	-	XB	ZB										X*			
2"	1"	UQ	UB			X*	X*	X*								
2"	1 1/4"	OQ	ON			X*	X*	ON*				X*	X*	X*		
2"	1 1/2"	OV	OS			X*	X*	X*					X*	X*		
2"	2"	OX	OX					X								
BSP Porting																
3/4"	-	YN	YQ	X*	X	YQ	YQ		X*	2500	2500	YQ	YQ			
-	3/4"	YQ	YN		X	YQ	YQ			2500	2500	YQ	YQ			
3/4"	3/4"	YS	YS	2000	X	X		X		2500	2500		X			
1"	3/4"	YV	YT	2000*	X*	YV*	YV*	YV		2500*	2500*	YV*	YV*			
1 1/4"	3/4"	YW	YU			YW*										
1"	-	SL	RQ		SL*	RQ*	RQ*	RQ	RQ	RQ		RQ*	SL*	RQ*	RQ*	
-	1"	RQ	SL					RQ	RQ	RQ				2500	RQ	RQ
1"	1"	MP	MP		2000	X	X	X						2500		X
1 1/4"	1"	IX	VY		2000*	X*	VY*	IX	IX					2500*	IX	IX
1 1/2"	1"	VI	HW													X
1 1/4"	-	NJ	UI				NJ*		UI	UI					UI	UI
-	1 1/4"	UI	NJ						UI	UI					UI	UI
1 1/4"	1 1/4"	PF	PF						X	X					X	X
1 1/2"	1 1/4"	IS	IQ													X*
Metric Straight Thread																
3/4"	-	EN	TQ	X*	TQ	TQ	TQ		X*	TQ*	TQ*	TQ	TQ			
-	3/4"	TQ	EN		TQ	TQ	TQ			2500	2500	TQ				
3/4"	3/4"	ES	ES	2000	X					2500						
1"	3/4"	EV	ET	2000*	X*	EV*	EV	EV		2500*	2500*	EV*	EV*			
1"	-	NL	ER			ER*	ER	ER	ER			ER*	ER*	ER*	ER	
-	1"	ER	NL				ER	ER	ER							
1"	1"	CM	CM		2000	X	X							2500		
1 1/4"	-	UA					UA*	UA	UA				UA*	UA	UA	
1 1/4"	1"	EX	VE		2000*	X*	EX*	EX	EX				2500*	X*	EX	EX
1 1/4"	1 1/4"	PA	PA				X	X	X						X	X
1 1/2"	1 1/4"	SA	QA				X*	X*	X						X*	X*

*This porting is acceptable for low pressure inlet port only.

NOTES

1. Shaded cells are acceptable for motor codes.
2. "X" Means both codes are available.
3. "2000" or "2500" indicates maximum pressure rating on port.



Box 6 Gear Housing <i>continued</i>																
050 Series					051 Series											
Housing Code	10	12	15	17	20	22	25	10	12	15	17	20	22	25		
Displacement (C.I.R.)	2.55	3.19	3.83	4.46	5.10	5.74	6.38	2.55	3.19	3.83	4.46	5.10	5.74	6.38		
Maximum (PSI)	2500	2500	2500	2000	2000	2000	2000	3000	3000	3000	3000	2500	2500	2500		
IN	OUT	CW	CCW													
¾"	-	VN	VQ	VQ	VQ	VQ	VQ	Metric Split Flange Porting								
-	¾"	VQ	VN	VQ	VQ	VQ	VQ	X*								
1"	¾"	RV	VT	X*	RV*	RV	RV	RV	RV	RV	RV	RV	RV	RV	RV	
1 ¼"	¾"	RW	RU													
1"	-	UL	UR	UR*	UR	UR	UR	UR	UR	UR	UR	UR	UR	UR	UR	
-	1"	UR	UL					UR	UR	UR	UR	UR	UR	UR	UR	UR
1"	1"	UM	UM	2000	X	X	X	X	X	X	X	X	X	X	X	
1 ¼"	1"	UX	VU	2000*	UX*	UX*	UX	UX	UX	UX	UX	UX	UX	UX	UX	
1 ½"	1"	VO	HO					X*	X*	X*	X*	X*	X*	X*	X*	X*
1 ¼"	-	NO	UO					UO*	UO	UO	UO	UO	UO	UO	UO	UO
-	1 ¼"	UO	NO					UO	UO	UO	UO	UO	UO	UO	UO	UO
1 ¼"	1 ¼"	PO	PO	2000	X	X	X	X	X	X	X	X	X	X	X	
1 ½"	1 ¼"	SO	QO	2000*	X*	X*	X	X	X	X	X	X	X	X	X	
1 ½"	-	UY	TO					X*	X*	X	X	X	X	X	X	
-	1 ½"	TO	UY					X	X	X	X	X	X	X	X	
1 ½"	1 ½"	SV	SV					X	X	X	X	X	X	X	X	
2"	1 ¼"	JM	JR					X*	X*	X*	X*	X*	X*	X*	X*	X*
2"	1 ½"	JQ	JN					X*	X*	X*	X*	X*	X*	X*	X*	X*

*This porting is acceptable for low pressure inlet port only.

NOTES

1. Shaded cells are acceptable for motor codes.
2. "X" Means both codes are available.
3. "2000" or "2500" indicates maximum pressure rating on port.

Box 7 Gear Width				
050 Series				
	Gear Width	in. ³ /rev.	cm ³ /rev.	Max Pressure
05	½"	1.28	20.9	2500 psi (172 bar)
07	¾"	1.91	31.3	2500 psi (172 bar)
10	1"	2.55	41.8	2500 psi (172 bar)
12	1 ¼"	3.19	52.2	2500 psi (172 bar)
15	1 ½"	3.83	62.7	2500 psi (172 bar)
17	1 ¾"	4.46	73.1	2000 psi (138 bar)
20	2"	5.10	83.6	2000 psi (138 bar)
22	2 ¼"	5.74	94.0	2000 psi (138 bar)
25	2 ½"	6.38	104.5	2000 psi (138 bar)
051 Series				
	Gear Width	in. ³ /rev.	cm ³ /rev.	Max Pressure
05	½"	1.28	20.9	3000 psi (207 bar)
07	¾"	1.91	31.3	3000 psi (207 bar)
10	1"	2.55	41.8	3000 psi (207 bar)
12	1 ¼"	3.19	52.2	3000 psi (207 bar)
15	1 ½"	3.83	62.7	3000 psi (207 bar)
17	1 ¾"	4.46	73.1	3000 psi (207 bar)
20	2"	5.10	83.6	2500 psi (172 bar)
22	2 ¼"	5.74	94.0	2500 psi (172 bar)
25	2 ½"	6.38	104.5	2500 psi (172 bar)

Box 8 Shaft Type <i>(type 1 unless noted)</i>	
For single, tandem, or two-piece shaft unless noted.	
07	SAE "C" 14 tooth spline 1.25" dia., ANSI 32-4
11	SAE "C" keyed 1.25" dia., 5/16"X15/32"X1 ½" key, ANSI 32-1
22	050-050, 051-051 piggyback shaft
23	075-050, 076-051 piggyback shaft
25	SAE "B" 13 tooth spline .88" dia., ANSI 22-4
43	SAE "B-B" keyed 1.00" dia. ¼"X3/8"X1 ¼" key, ANSI 25-1
53	SAE "C" 14 tooth spline 1.25" dia., ANSI-32-4, type 2 (single & tandem)
65	SAE "B" 13 tooth spline .88" dia., ANSI 22-4, type 2 (single & tandem)
67	SAE "B-B" keyed 1.00 dia., ¼"X3/8"X1 ¼" key, ANSI 25-1, type 2 (single & tandem)
73	SAE "C" keyed 1.25" dia., 5/16" x 15/32" x 2 ¼" key, extended length (two-piece only)
98	SAE "B-B" 15 tooth spline, 1.00" dia., ANSI 25-4 (single & tandem)

Box 9 Bearing Carriers Pump Only

Common Inlet Passage

IN	OUT	CW	CCW
-	-		
		C	D

* - - - **A** **U**
 * 051 Series only. Used when only one adjacent gear housing has an inlet port.

**NPT Porting
 (050 Series only)**

1"	-	TB	BT
1 1/4"	-	VB	BV
1 1/2"	-	WB	BW
1"	3/4"	TX	XT
1 1/4"	3/4"	VX	XV
1 1/2"	3/4"	WX	XW
1 1/4"	1"	VZ	ZV
1 1/2"	1"	WZ	ZW
1"	3/4"	TJ	JT
1 1/4"	3/4"	VJ	JV
1 1/4"	1"	VK	KV
1 1/2"	1"	WK	KW
1"	3/4"	ZX	XZ

ODT Porting

1"	-	CB	BC
1 1/4"	-	DB	BD
1 1/2"	-	FB	BF
-	3/4"	PJ	*JP
1"	3/4"	CJ	JC
1 1/4"	3/4"	DJ	JD
1 1/2"	3/4"	FJ	JF
1 1/4"	1"	DK	KD
1 1/2"	1"	FK	KF
* 051 Series only.			
1"	3/4"	CR	RC
1 1/4"	3/4"	DR	RD
* 1 1/2"	3/4"	FR	RF
1 1/4"	1"	DS	SD
1 1/2"	1"	FS	SF
-	1"	HZ	*ZH
* 051 Series only.			
1"	3/4"	KJ	JK

Split Flange Porting

IN	OUT	CW	CCW
1"	-	LB	BL
1 1/4"	-	MB	BM
1 1/2"	-	NB	BN
-	3/4"	BR	RB
1"	3/4"	LR	RL
1 1/4"	3/4"	MR	RM
1 1/2"	3/4"	NR	RN
1 1/4"	1"	MS	SM
1 1/2"	1"	NS	SN
1"	3/4"	LX	XL
1 1/4"	3/4"	MX	XM
1 1/4"	1"	MZ	ZM
1 1/2"	1"	NZ	ZN
1"	3/4"	SR	RS

BSPB Porting

1"	-	CX	XC
1 1/4"	-	DX	XD
1 1/2"	-	FX	XF
* -	3/4"	-	TL
1"	3/4"	CT	TC
1 1/4"	3/4"	DT	TD
1 1/2"	3/4"	FT	TF
1 1/4"	1"	DV	VD
1 1/2"	1"	FV	VF
* 050 Series only.			
1"	3/4"	GM	MG
1 1/4"	3/4"	HM	MH
1 1/2"	3/4"	WM	MW
1 1/4"	1"	HN	NH
1 1/2"	1"	WN	NW
1"	3/4"	PN	NP

Bearing Carriers (9) Pump Only - continued

Metric Split Flange Porting

IN	OUT	CW	CCW
1"	-	CH	HC
1 1/4"	-	DH	HD
1 1/2"	-	FH	HF
-	3/4"	PW	WP
1"	3/4"	CW	WC
1 1/4"	3/4"	DW	WD
1 1/2"	3/4"	FW	WF
1 1/4"	1"	DC	CD
1 1/2"	1"	FC	CF
1"	3/4"	GQ	QG
1 1/4"	3/4"	HQ	QH
1 1/2"	3/4"	WQ	QW
1 1/4"	1"	HS	SH
1 1/2"	1"	WS	SW
1"	3/4"	ST	TS

Metric Straight Thread Porting

IN	OUT	CW	CCW
1"	-	CL	LC
1 1/4"	-	DL	LD
1 1/2"	-	FL	LF
1"	3/4"	CZ	ZC
1 1/4"	3/4"	DZ	ZD
1 1/2"	3/4"	FZ	ZF
1 1/4"	1"	DN	ND
1 1/2"	1"	FN	NF
1"	3/4"	GT	TG
1 1/4"	3/4"	HT	TH
1 1/2"	3/4"	WT	TW
1 1/4"	1"	HV	VH
1 1/2"	1"	WV	VW
1"	3/4"	KL	LK

Box 9 Bearing Carriers (Motor Only)

No Ports

IN	OUT	DUAL
-	-	B

**NPT Porting
 (030 Series only)**

1"	1"	TT
1 1/4"	1 1/4"	VV
1 1/2"	1 1/2"	WW

ODT Porting

1"	1"	CC
1 1/4"	1 1/4"	BB
1 1/2"	1 1/2"	FF

Split Flange Porting

1"	1"	LL
1 1/4"	1 1/4"	MM
1 1/2"	1 1/2"	NN

BSPB Porting

IN	OUT	DUAL
1"	1"	EE
1 1/4"	1 1/4"	GG

Metric Split Flange Porting

1"	1"	RR
1 1/4"	1 1/4"	SS

Metric Straight Thread Porting

1"	1"	KK
1 1/4"	1 1/4"	JJ

Box 10 Connecting Shaft

For connecting tandem units.

- 1 Connecting Shaft - Multiple Units
- 22 Piggyback Pump Connecting Shaft for 050 to 050, 051 to 051
- 23 Piggyback Pump Connecting Shaft for 075 to 050, 076 to 051

NOTE
 Split flange thread depths may be more shallow than S.A.E. standard.
 Contact Product Support Department for actual dimensions.

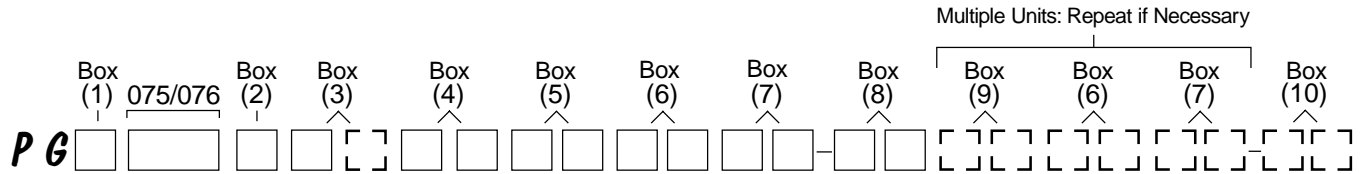

Box 1 Pump/Motor	
P	Pump
M	Motor

Box 2 Unit	
A	Single Unit
B	Tandem Unit
C	Single or Tandem w/ two-piece shaft (O.B. bearing required)

Box 3 Shaft End Cover	
1	Pump, cw w/o O.B. bearing
2	Pump, ccw w/o O.B. bearing
3	Pump, bi-rotational w/o O.B. bearing (075 series only)
4	Pump, cw with O.B. bearing
5	Pump, ccw with O.B. bearing
6	Pump, bi-rotational w/ O.B. bearing (075 series only)
8	Motor, bi-rot. with O.B. bearing + ¼" NPT drain
9	Motor, bi-rot. w/o O.B. bearing + ¼" NPT drain
18	Motor, bi-rot. with O.B. bearing + ¼" BSPP drain
19	Motor, bi-rot. w/o O.B. bearing + ¼" BSPP drain

Box 4 Shaft End Cover (type 1 only)	
42	SAE 4 bolt "B" ANSI 101-4: Port dia. 4"
78	SAE 4 bolt "C" ANSI 127-4: Port dia. 5"
80	SAE 4 bolt "D" ANSI 152-4: Port dia. 6"
98	SAE 2 bolt "C" ANSI 127-2: Port dia. 5"

Box 5 Port End Cover (Rear Ported)				
Left	Right	Single	Tandem	Extended Studs
<i>Unported</i>				
-	-	BE	BI	BY

O.D.T. Porting				
1"	1"	JE	JI	JY

Metric Straight Thread				
1"	1"	TE	TI	TY

Piggyback Port End - Pump Only				
Type 075-050, 076-051 & 075-030, 076-031				
			CW	CCW
			Double	
		KO	LO	MO

For All Units
 To determine direction of shaft rotation, view the unit with the shaft pointing toward you, and the idler (driven) gear beneath the shaft. With clockwise rotation, flow will be left to right. The inlet pump port will be on the left, outlet on the right. The flow is in the opposite direction with counter-clockwise rotation. Inverting the pump will reverse the inlet and outlet ports but not the direction of rotation.

Gear Housing (6)																		
075 Series										075/076 Series		076 Series						
Housing Code	07	10	12	15	17	20	22	25	27	30	10	12	15	17	20	22	25	
Displacement (C.I.R.)	3.07	4.1	5.12	6.15	7.17	8.2	9.22	10.25	11.275	12.3	4.1	5.12	6.15	7.17	8.2	9.22	10.25	
Maximum (PSI)	2500	2500	2500	2500	2500	2500	2250	2250	2000	2000	3000	3000	3000	3000	2500	2500	2500	
IN	OUT	CW		CCW														
-	-	AB	AB	X	X	X	X	X	X	X	X	X	X	X	X	X	X	No Porting
																		NPT Porting
3/4"	-	IC	ID	ID	ID	ID	ID	ID										
-	3/4"	ID	IC	ID	ID	ID	ID	ID										
1"	3/4"	IJ	IG		X	IJ	IJ											
1"	-	YC	YD			YD	YD		X/-									
-	1"	YD	YC			YD	YD		X/-									
1"	1"	YF	YF		X	X												
1 1/4"	1"	YJ	YG		X	X												
1 1/4"	1 1/4"	YL	YL		X	X	X											
																		OD Tube Porting
3/4"	-	EC	ED	ED	ED	ED	ED											
1"	3/4"	EJ	EG	X*		EJ	EJ											2500*
1 1/4"	3/4"	EK	EH		X*													X*
1"	-	AC	AD			AD	AD											2500 X
-	1"	AD	AC			AD	AD											2500 X
1"	1"	AF	AF		2000	X	X	X	X/-									2500 X
1 1/4"	1"	AJ	AG		2000*	X*												2500* X*
1 1/2"	1"	AK	AH				X*											X*
1 1/4"	1 1/4"	AL	AL			2000	2000	2000/-	X	X								X/-
1 1/2"	1 1/4"	AP	AM			2000*	2000*											
1 1/2"	1 1/2"	AR	AR						X	X								
																		Split Flange Porting
3/4"	-	UC	UD	UD	UD	UD	UD											
-	3/4"	UD	UC	UD	UD	UD	UD											
1"	3/4"	UJ	UG	X	X	UJ	UJ	UJ	UJ									X
1"	-	OC	OD		OD	X	OD	OD	OD									
-	1"	OD	OC		OD	X	OD	OD	OD									
1"	1"	OF	OF		X	X	X	X	X/X		X							X/- X/- X X X X
1 1/4"	1"	OJ	OG		2000*	X	X	OJ	OJ/-	OJ	OJ							X* X* X*
1 1/2"	1"	OK	OH			X*	X*	X*	X/-	X								X* X* X*
1 1/4"	-	OA	OB			OB	OB	OB	OB/-	OB	OB							
-	1 1/4"	OB	OA			OB	OB	OB	OB/-	OB	OB							
1 1/4"	1 1/4"	OL	OL		2000	X	X	X	X/X	X	X	X/X	X/X		2500	X	X	X X X
1 1/2"	1 1/4"	OP	OM			X*	X*	X*	X/X	X	X	OP/-	OP/-		2500*	X*	X*	X
1 1/2"	-	OE	OU					X/X	X	OU		OU/-	OU/-					X
-	1 1/2"	OU	OE					X/X	X	OU		OU/-	OU/-					X
1 1/2"	1 1/2"	OR	OR			2000	2000	X/X	X	X	X/X	X/X						X X
2"	1"	UQ	-					X*/-										
2"	1 1/4"	OQ	ON				X*	X*/X*	X*	X*	X/X	X/X						X* X* X*
2"	1 1/2"	OV	OS			2000*	X*/X*	X*	X*	X/X	X/X							X* X*
2"	2"	OX	OX						X	X/X	X/X							
2 1/2"	1 1/4"	US	UN						X*									
2 1/2"	1 1/2"	OW	OT					X*	X*/X*	X*/X*							X*	
2 1/2"	2"	OZ	OY						X*/-									

* This porting is acceptable for low pressure inlet port only.

NOTES

1. NPT ports are not recommended for use at pressures in excess of 1500 PSI.
2. Shaded cells are acceptable for motor codes.
3. "X" Means both codes are available.
4. "2000" or "2500" indicates maximum pressure rating on port.



Gear Housing (6) continued																		
		075 Series							075/076 Series		076 Series							
Housing Code	07	10	12	15	17	20	22	25	27	30	10	12	15	17	20	22	25	
Displacement (C.I.R.)	3.07	4.1	5.12	6.15	7.17	8.2	9.22	10.25	11.275	12.3	4.1	5.12	6.15	7.17	8.2	9.22	10.25	
Maximum (PSI)	2500	2500	2500	2500	2500	2500	2250	2250	2000	2000	3000	3000	3000	3000	2500	2500	2500	
IN	OUT	CW	CCW															
3/4"	-	YN	YQ	YQ	YQ	YQ	YQ	YQ	YQ	YQ	YQ	YQ	YQ	YQ	YQ	YQ	YQ	BSPP Porting
-	3/4"	YQ	YN	YQ	YQ	YQ	YQ	YQ	YQ	YQ	YQ	YQ	YQ	YQ	YQ	YQ	YQ	
3/4"	3/4"	YS	YS															
1"	3/4"	YV	YT	X*	YV*	YV	YV	YV	YV	YV	YV	YV	YV	YV	YV	YV	YV	
1"	-	SL	RQ		X	RQ	RQ	RQ/RQ	RQ		SL*	RQ*	RQ				RQ	
-	1"	RQ	SL		X	RQ	RQ	RQ/RQ	RQ				RQ				RQ	
1"	1"	MP	MP		2000	X	X											
1 1/4"	1"	IX	VY		2000*	X*	IX*	IX/-	IX		IX/-							
1 1/4"	-	NJ	UI			UI*												
-	1 1/4"	UI	NJ															
1 1/4"	1 1/4"	PF	PF		2000	2000	X/-	X		-/X					X	X		
1 1/2"	1"	VI	HW			X*	VI*	-/VI*										
1 1/2"	1 1/4"	IS	IQ		2000*	2000*	-/X*											
Metric Straight Thread																		
3/4"	-	EN	TQ	TQ	TQ	TQ	TQ	TQ			TQ	TQ	TQ					
-	3/4"	TQ	EN	TQ	TQ	TQ	TQ	TQ			TQ	TQ	TQ					
1"	3/4"	EV	ET	X*		EV	EV											
1"	-	NL	ER															
-	1"	ER	NL			ER	ER											
1"	1"	CM	CM		2000	X	X											
Metric Split Flange Porting																		
3/4"	-	VN	VQ	VQ	VQ	VQ	VQ											
-	3/4"	VQ	VN	VQ	VQ	VQ	VQ											
1"	3/4"	RV	VT	X	X	RV	RV	RV	RV/-		X							
1"	-	UL	UR		UR	UR	UR	UR	UR/-									
-	1"	UR	UL		UR	UR	UR	UR	UR/-									
1"	1"	UM	UM		X	X	X	X	X/X		X	X	X	X				
1 1/4"	1"	UX	VU		X*	X	UX	UX	UX/-	UX	UX							
1 1/2"	1"	VO	HO			X*	X*											
1 1/4"	-	NO	UO			UO	UO	UO	UO/-	UO	UO							
-	1 1/4"	UO	NO			UO	UO	UO	UO/-	UO	UO							
1 1/4"	1 1/4"	PO	PO		X	X	X	X/X	X	X	X/X	X/X	2500	X	X	X	X	
1 1/2"	1 1/4"	SO	QO			X*	X*	X/X	X	SO	SO	SO	2500*	X*	X*			
1 1/2"	-	UY	TO					X/X	X	X	TO	TO			X*	X		
-	1 1/2"	TO	UY					X/X	X	X	TO	TO				X		
1 1/2"	1 1/2"	SV	SV			2000	X/X	X	X	X/X	X/X					X	X	
2"	1 1/4"	JM	JR			X*	X*/X*	X*	X*	-/X*	-/X*			X*	X*	X*		
2"	1 1/2"	JQ	JN			2000*	X*/X*	X*	X*	X/X	X/X				X*	X*		
2"	2"	JS	JS															
2 1/2"	1 1/2"	LJ	JX													X*		

* This porting is acceptable for low pressure inlet port only.

NOTES

1. Shaded cells are acceptable for motor codes.
2. "X" Means both codes are available.
3. "2000" or "2500" indicates maximum pressure rating on port.



Box 7 Gear Width

075 Series				
	Gear Width	in. ³ /rev.	cm ³ /rev.	Max Pressure
07	¾"	3.08	50.4	2500 psi (172 bar)
10	1"	4.10	67.2	2500 psi (172 bar)
12	1 ¼"	5.13	84.0	2500 psi (172 bar)
15	1 ½"	6.15	100.8	2500 psi (172 bar)
17	1 ¾"	7.18	117.6	2500 psi (172 bar)
20	2"	8.20	134.4	2500 psi (172 bar)
22	2 ¼"	9.23	151.2	2250 psi (155 bar)
25	2 ½"	10.25	168.0	2250 psi (155 bar)
27	2 ¾"	11.28	184.8	2000 psi (138 bar)
30	3"	12.30	201.6	2000 psi (138 bar)

076 Series				
	Gear Width	in. ³ /rev.	cm ³ /rev.	Max Pressure
07	¾"	3.08	50.4	3000 psi (207 bar)
10	1"	4.10	67.2	3000 psi (207 bar)
12	1 ¼"	5.13	84.0	3000 psi (207 bar)
15	1 ½"	6.15	100.8	3000 psi (207 bar)
17	1 ¾"	7.18	117.6	3000 psi (207 bar)
20	2"	8.20	134.4	2500 psi (172 bar)
22	2 ¼"	9.23	151.2	2500 psi (172 bar)
25	2 ½"	10.25	168.0	2500 psi (172 bar)
27	2 ¾"	11.28	184.8	2000 psi (138 bar)
30	3"	12.30	201.6	2000 psi (138 bar)

Box 8 Shaft Type

For single, tandem, or two-piece shaft unless noted.

- 07 SAE "C" 14 tooth spline 1.25" dia., ANSI 32-4
- 11 SAE "C" keyed 1.25" dia., 5/16"X15/32"X1 ½" key, ANSI 32-1

Box 9 Bearing Carriers (Pump Only)

Common Inlet Passage

- - C D

* - - A U

* 076 Series only. Used when only one adjacent gear housing has an inlet port.

Box 9 Bearing Carriers (Motor Only)

No Ports

IN	OUT	DUAL
-	-	B

ODT Porting

1"	1"	CC
1 ¼"	1 ¼"	BB

Split Flange Porting

* 1"	1"	LL
1 ¼"	1 ¼"	MM
1 ½"	1 ½"	NN

* 076 Series only.

BSP Porting

1"	1"	EE
1 ¼"	1 ¼"	GG
1 ½"	1 ½"	HH

Metric Split Flange Porting

IN	OUT	DUAL
1"	1"	RR
1 ¼"	1 ¼"	SS
1 ½"	1 ½"	XX

Metric Straight Thread Porting

1"	1"	KK
1 ¼"	1 ¼"	JJ
1 ½"	1 ½"	ZZ

Box 10 Connecting Shaft

- For connecting tandem units.**
- 1 Connecting Shaft - Multiple Units
 - 23 Piggyback Pump Connecting Shaft for 075 to 075

NOTE
 Split flange thread depths may be more shallow than S.A.E. standard.
 Contact Product Support Department for actual dimensions.

Offer of Sale

The items described in this document are hereby offered for sale at prices to be established by Parker Hannifin Corporation, its subsidiaries and its authorized distributors. This offer and its acceptance by any customer ("Buyer") shall be governed by all of the following Terms and Conditions. Buyer's order for any item described in its document, when communicated to Parker Hannifin Corporation, its subsidiary or an authorized distributor ("Seller") verbally or in writing, shall constitute acceptance of this offer.

1. Terms and Conditions of Sale: All descriptions, quotations, proposals, offers, acknowledgments, acceptances and sales of Seller's products are subject to and shall be governed exclusively by the terms and conditions stated herein. Buyer's acceptance of any offer to sell is limited to these terms and conditions. Any terms or conditions in addition to, or inconsistent with those stated herein, proposed by Buyer in any acceptance of an offer by Seller, are hereby objected to. No such additional, different or inconsistent terms and conditions shall become part of the contract between Buyer and Seller unless expressly accepted in writing by Seller. Seller's acceptance of any offer to purchase by Buyer is expressly conditional upon Buyer's assent to all the terms and conditions stated herein, including any terms in addition to, or inconsistent with those contained in Buyer's offer. Acceptance of Seller's products shall in all events constitute such assent.

2. Payment: Payment shall be made by Buyer net 30 days from the date of delivery of the items purchased hereunder. Any claims by Buyer for omissions or shortages in a shipment shall be waived unless Seller receives notice thereof within 30 days after Buyer's receipt of the shipment.

3. Delivery: Unless otherwise provided on the face hereof, delivery shall be made F.O.B. Seller's plant. Regardless of the method of delivery, however, risk of loss shall pass to Buyer upon Seller's delivery to a carrier. Any delivery dates shown are approximate only and Seller shall have no liability for any delays in delivery.

4. Warranty: Seller warrants that the item sold hereunder shall be free from defects in material or workmanship for a period of 547 days from the date of shipment to Buyer, or 3,000 hours of use, whichever expires first. **THIS WARRANTY COMPRISES THE SOLE AND ENTIRE WARRANTY PERTAINING TO ITEMS PROVIDED HEREUNDER. SELLER MAKES NO OTHER WARRANTY, GUARANTEE, OR REPRESENTATION OF ANY KIND WHATSOEVER. ALL OTHER WARRANTIES, INCLUDING BUT NOT LIMITED TO, MERCHANTABILITY AND FITNESS FOR PURPOSE, WHETHER EXPRESS, IMPLIED, OR ARISING BY OPERATION OF LAW, TRADE USAGE, OR COURSE OF DEALING ARE HEREBY DISCLAIMED.**

NOTWITHSTANDING THE FOREGOING, THERE ARE NO WARRANTIES WHATSOEVER ON ITEMS BUILT OR ACQUIRED WHOLLY OR PARTIALLY, TO BUYERS DESIGNS OR SPECIFICATIONS.

5. Limitation of Remedy: SELLER'S LIABILITY ARISING FROM OR IN ANY WAY CONNECTED WITH THE ITEMS SOLD OR THIS CONTRACT SHALL BE LIMITED EXCLUSIVELY TO REPAIR OR REPLACEMENT OF THE ITEMS SOLD OR REFUND OF THE PURCHASE PRICE PAID BY BUYER, AT SELLER'S SOLE OPTION IN NO EVENT SHALL SELLER BE LIABLE FOR ANY INCIDENTAL OR SEQUENTIAL OR SPECIAL DAMAGES OF ANY KIND OR NATURE WHATSOEVER, INCLUDING BUT NOT LIMITED TO LOST PROFITS ARISING FROM OR IN ANY WAY CONNECTED WITH THIS AGREEMENT OR ITEM SOLD HEREUNDER, WHETHER ALLEGED TO ARISE FROM BREACH OF CONTRACT, EXPRESS OR IMPLIED WARRANTY, OR IN TORT, INCLUDING WITHOUT LIMITATION, NEGLIGENCE, FAILURE TO WARN OR STRICT LIABILITY.

6. Changes, Reschedules and Cancellations: Buyer may request to modify the designs or specifications for the items sold hereunder as well as the quantities and delivery dates thereof, or may request to cancel all or part of this order, however, no such requested modification or cancellation shall become part of the contract between Buyer and Seller unless accepted by Seller in a written amendment to this Agreement. Acceptance of any such requested modification or cancellation shall be at Seller's discretion, and shall be upon such terms and conditions as Seller may require.

7. Special Tooling: A tooling charge may be imposed for any special tooling, including without limitation, dies, fixtures, molds and patterns, acquired to manufacture items sold pursuant to this contract. Such special tooling shall be and remain Seller's property notwithstanding payment of any charges by Buyer. In no event will Buyer acquire any interest in apparatus belonging to Seller which is utilized in the manufacture of the items sold hereunder, even if such apparatus has been specially converted or adapted for such manufacture and notwithstanding any charges paid by Buyer. Unless otherwise agreed, Seller shall have the right to alter, discard or otherwise dispose of any special tooling or other property in its sole discretion at any time.

8. Buyer's Property: Any designs, tools, patterns, materials, drawings, confidential information or equipment furnished by Buyer or any other items which become Buyer's property, may be considered obsolete and may be destroyed by Seller after two (2) consecutive years have elapsed without Buyer placing an order for the items which are manufactured using such property. Seller shall not be responsible for any loss or damage to such property while it is in Seller's possession or control.

9. Taxes: Unless otherwise indicated on the face hereof, all prices and charges are exclusive of excise, sales, use, property, occupational or like taxes which may be imposed by any taxing authority upon the manufacture, sale or delivery of the items sold hereunder. If any such taxes must be paid by Seller or if Seller is liable for the collection of such tax, the amount thereof shall be in addition to the amounts for the items sold. Buyer agrees to pay all such taxes or to reimburse Seller therefore upon receipt of its invoice. If Buyer claims exemption from any sales, use or other tax imposed by any taxing authority, Buyer shall save Seller harmless from and against any such tax, together with any interest or penalties thereon which may be assessed if the items are held to be taxable.

10. Indemnity For Infringement of Intellectual Property Rights: Seller shall have no liability for infringement of any patents, trademarks, copyrights, trade dress, trade secrets or similar rights except as provided in this Part 10. Seller will defend and indemnify Buyer against allegations of infringement of U.S. patents, U.S. trademarks, copyrights, trade dress and trade secrets (hereinafter 'Intellectual Property Rights'). Seller will defend at its expense and will pay the cost of any settlement or damages awarded in an action brought against Buyer based on an allegation that an item sold pursuant to this contract infringes the Intellectual Property Rights of a third party. Seller's obligation to defend and indemnify Buyer is contingent on Buyer notifying Seller within ten (10) days after Buyer becomes aware of such allegations of infringement, and Seller having sole control over the defense of any allegations or actions including all negotiations for settlement or compromise. If an item sold hereunder is subject to a claim that it infringes the Intellectual Property Rights of a third party, Seller may, at its sole expense and option, procure for Buyer the right to continue using said item, replace or modify said item so as to make it noninfringing, or offer to accept return of said item and return the purchase price less a reasonable allowance for depreciation. Notwithstanding the foregoing Seller shall have no liability for claims of infringement based on information provided by Buyer, or directed to items delivered hereunder for which the designs are specified in whole or part by Buyer, or infringements resulting from the modification, combination or use in a system of any item sold hereunder. The foregoing provisions of this Part 10 shall constitute Seller's sole and exclusive liability and Buyer's sole and exclusive remedy for infringement of Intellectual Property Rights.

If a claim is based on information provided by Buyer or if the design for an item delivered hereunder is specified in whole or in part by Buyer, Buyer shall defend and indemnify Seller for all costs, expenses or judgments resulting from any claim that such item infringes any patent, trademark, copyright, trade dress, trade secret or any similar right.

11. Force Majeure: Seller does not assume the risk of and shall not be liable for delay or failure to perform any of Seller's obligations by reason of circumstances beyond the reasonable control of Seller (hereinafter 'Events of Force Majeure'). Events of Force Majeure shall include without limitation, accidents, acts of God, strikes or labor disputes, acts, laws, rules or regulations of any government or government agency, fires, floods, delays or failures in delivery of carriers or suppliers, shortages of materials and any other cause beyond Seller's control.

12. Entire Agreement/Governing Law: The terms and conditions set forth herein, together with any amendments, modifications and any different terms or conditions expressly accepted by Seller in writing, shall constitute the entire Agreement concerning the items sold, and there are no oral or other representations or agreements which pertain thereto. This Agreement shall be governed in all respects by the law of the State of Ohio. No actions arising out of the sale of the items sold hereunder or this Agreement may be brought by either party more than two (2) years after the cause of action accrues.



Parker Hannifin Corporation
 6035 Parkland Blvd.
 Cleveland, Ohio 44124-4141
 Telephone: (216) 896-3000
 Fax: (216) 896-4000
 Web site: www.parker.com

Parker Hannifin Corporation

About Parker Hannifin Corporation

Parker Hannifin is a leading global motion-control company dedicated to delivering premier customer service. A Fortune 500 corporation listed on the New York Stock Exchange (PH), our components and systems comprise over 1,400 product lines that control motion in some 1,000 industrial and aerospace markets. Parker is the only manufacturer to offer its customers a choice of hydraulic, pneumatic, and electromechanical motion-control solutions. Our Company has the largest distribution network in its field, with over 7,500 distributors serving more than 350,000 customers worldwide.

Parker's Charter

To be a leading worldwide manufacturer of components and systems for the builders and users of durable goods. More specifically, we will design, market and manufacture products controlling motion, flow and pressure. We will achieve profitable growth through premier customer service.

Product Information

North American customers seeking product information, the location of a nearby distributor, or repair services will receive prompt attention by calling the Parker Product Information Center at our toll-free number: 1-800-C-PARKER (1-800-272-7537). In the UK, a similar service is available by calling 0500-103-203.

The Aerospace Group

is a leader in the development, design, manufacture and servicing of control systems and components for aerospace and related high-technology markets, while achieving growth through premier customer service.



The Climate & Industrial Controls Group

designs, manufactures and markets system-control and fluid-handling components and systems to refrigeration, air-conditioning and industrial customers worldwide.



The Fluid Connectors Group

designs, manufactures and markets rigid and flexible connectors, and associated products used in pneumatic and fluid systems.



The Seal Group designs, manufactures and distributes industrial and commercial sealing devices and related products by providing superior quality and total customer satisfaction.



The Hydraulics Group

designs, produces and markets a full spectrum of hydraulic components and systems to builders and users of industrial and mobile machinery and equipment.



The Filtration Group

designs, manufactures and markets quality filtration and clarification products, providing customers with the best value, quality, technical support, and global availability.



The Automation Group

is a leading supplier of pneumatic and electro-mechanical components and systems to automation customers worldwide.



The Instrumentation Group

is a global leader in the design, manufacture and distribution of high-quality critical flow components for worldwide process instrumentation, ultra-high-purity, medical and analytical applications.



Sales Offices Worldwide

North America

Gear Pump Division Headquarters

101 Canterbury Road

Kings Mountain, NC 28086

phone 704 730 2000

fax 704 730 5832

toll free 888 700 7411

Gear Pump Division Facility

2701 Intertech Drive

Youngstown, OH 44509

phone 330 270 6000

fax 330 270 6185

toll free 888 700 7511

Catalog HY09-020/US, T&M, 5M 07/08

Parker Hannifin Corporation

Gear Pump Division

101 Canterbury Road

Kings Mountain, NC USA

www.parker.com



Your Local Authorized Parker Distributor